

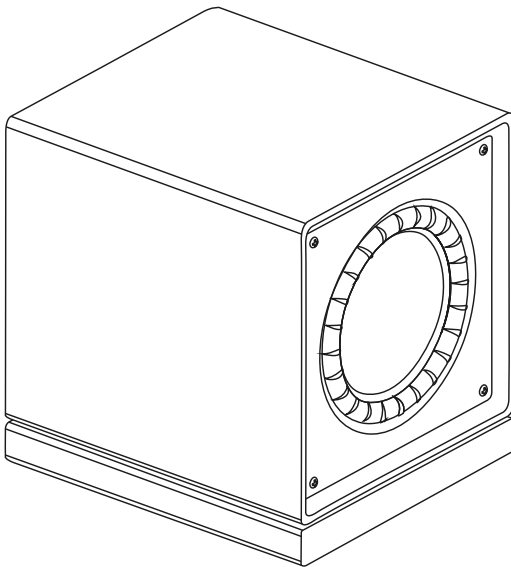

**OWNER'S MANUAL**  
**MEGA Powered Subwoofers**

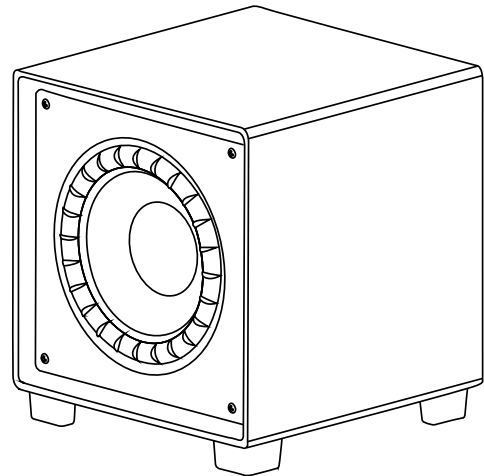

**D Series - Dual Driver Series**  
ES-SUB-MEGA-D8  
ES-SUB-MEGA-D10  
ES-SUB-MEGA-D12



**S Series - Single Driver Series**  
ES-SUB-MEGA-S8  
ES-SUB-MEGA-S10  
ES-SUB-MEGA-S12  
ES-SUB-MEGA-S15

**REAL. LIFE. SOUND.**

## REGULATORY COMPLIANCE & SAFETY INFORMATION

1. Read these instructions.  
Lisez ces instructions.
2. Keep these instructions.  
Conservez ces instructions
3. Heed all warnings.  
Respectez tous les avertissements.
4. Follow all instructions.  
Suivez toutes les instructions.
5. Do not use this apparatus near water.  
Ne pas utiliser cet appareil près de l'eau.
6. Clean only with dry cloth.  
Nettoyez-le uniquement avec un chiffon sec.
7. Do not block any ventilation openings. Install in accordance with the manufacturer's instructions.  
Ne pas bloquer les ouvertures de ventilation. Installer conformément aux instructions du fabricant.
8. Do not install near any heat sources such as radiators, heat registers, stoves, or other apparatus (including amplifiers) that produce heat.  
Ne pas installer près de sources de chaleur telles que des radiateurs, registres de chaleur, poêles, ou autres appareils (incluant les amplificateurs) qui produisent de la chaleur.
9. Do not defeat the safety purpose of the polarized or grounding-type plug. A polarized plug has two blades with one wider than the other. A grounding type plug has two blades and a third grounding prong. The wide bladed or the third prong are provided for your safety. If the provided plug does not fit into your outlet, consult an electrician for replacement of the obsolete outlet.  
Ne pas contourner le dispositif de sécurité de la fiche polarisée ou de mise à la terre. Une fiche polarisée possède deux lames dont une plus large que l'autre. Une fiche de terre a deux lames et une troisième broche de terre. La lame large ou la troisième broche est fournie pour votre sécurité. Si la fiche fournie ne s'adapte pas à votre prise, consultez un électricien pour le remplacement de la prise obsolète.
10. Protect the power cord from being walked on or pinched particularly at plugs, convenience receptacles, and the point where they exit from the apparatus.  
Protégez le cordon d'alimentation ne soit piétiné ou pincé, en particulier au niveau des fiches, des prises et au point où il sort de l'appareil.
11. Only use attachments/accessories specified by the manufacturer.  
Utilisez uniquement des fixations / accessoires spécifiés par le fabricant.
12. Use only with the cart, stand, tripod, bracket, or table specified by the manufacturer, or sold with the apparatus. When a cart is used, use caution when moving the cart/apparatus combination to avoid injury from tip-over.  
Utilisez uniquement avec le chariot, le socle, le trépied, le support ou la table spécifiés par le fabricant ou vendu avec l'appareil. Lorsque vous utilisez un chariot, soyez prudent lorsque vous déplacez l'ensemble chariot / appareil pour éviter des blessures dues au renversement.



13. Unplug this apparatus during lightning storms or when unused for long periods of time.  
Débranchez cet appareil pendant les orages ou lorsqu'il n'est pas utilisé pendant de longues périodes de temps.
14. Refer all servicing to qualified service personnel. Servicing is required when the apparatus has been damaged in any way, such as power-supply cord or plug is damaged, liquid has been spilled or objects have fallen into the apparatus, the apparatus has been exposed to rain or moisture, does not operate normally, or has been dropped. Confiez toutes les réparations à un personnel qualifié. Une réparation est nécessaire lorsque l'appareil a été endommagé de quelque façon que ce soit le cordon d'alimentation ou la fiche est endommagé, du liquide a été renversé ou si des objets sont tombés dans l'appareil, l'appareil a été exposé à la pluie ou à l'humidité, ne fonctionne pas normalement, ou s'il est tombé.
15. This equipment uses AC power which can be subjected to electrical surges, typically lightning transients which are very destructive to customer terminal equipment connected to AC power sources. The warranty for this equipment does not cover damage caused by electrical surge or lightning transients. To reduce the risk of this equipment becoming damaged it is suggested that the customer consider installing a surge arrester.  
Cet équipement utilise la puissance AC qui peuvent être soumis à des surtensions électriques, la foudre généralement transitoires qui sont très destructives envers les équipements terminaux connectés à des sources d'alimentation CA. La garantie de cet appareil ne couvre pas les dommages causés par les surtensions électriques ou transitoires de foudre. Pour réduire le risque de cet équipement devient endommagé, il est suggéré que le client envisager l'installation d'un limiteur de surtension.
16. The socket-outlet providing power to the equipment shall be easily accessible. To completely disconnect unit power



from the AC mains, remove the power cord from the socket-outlet or turn off the circuit breaker that supplies the AC mains power to the socket-outlet.

La prise de courant qui alimente l'équipement doit être facilement accessible. Pour déconnecter complètement l'alimentation de l'unité du secteur, débranchez le cordon d'alimentation de la prise de courant ou éteignez le disjoncteur qui fournit l'alimentation secteur à la prise de courant.

- 17.** This product relies on the buildings installation for short-circuit (overcurrent) protection. Ensure that the protective device is rated not greater than: 20A.

Ce produit repose sur l'installation des bâtiments pour les courts-circuits (surintensité) de protection. Assurez-vous que le dispositif de protection est assignée ne dépassant pas: 20A.

- 18.** Never push objects of any kind into this product through cabinet slots as they may touch dangerous voltage points or short out parts that could result in fire or electric shock.

N'introduisez jamais d'objets d'aucune sorte dans ce produit à travers les fentes du boîtier car ils pourraient toucher des points de tension dangereux ou court-circuiter des pièces qui pourraient entraîner un incendie ou un choc électrique.

- 19.** This product can interfere with electrical equipment such as tape recorders, TV sets, radios, computers and microwave ovens if placed in close proximity.

Ce produit peut interférer avec des appareils électriques tels que les magnétophones, téléviseurs, radios, ordinateurs et fours à micro-ondes si placés à proximité.

- 20.** This product shall be used at maximum 35 degree Celsius ambient temperature.

Ce produit doit être utilisé à une température ambiante maximale de 35 degrés Celsius.



The lightning flash and arrow head within the triangle is a warning sign alerting you of dangerous voltage inside the product

L'éclair et la flèche dans le triangle est un signe d'alerte pour vous avertir d'une tension dangereuse à l'intérieur du produit



Caution: To reduce the risk of electric shock, do not remove cover (or back). No user serviceable parts inside. Refer servicing to qualified service personnel.

Attention: Pour réduire le risque de choc électrique, ne pas retirer le couvercle (ou l'arrière). Aucune pièce réparable par l'utilisateur. Confiez l'entretien à un personnel qualifié.



The exclamation point within the triangle is a warning sign alerting you of important instructions accompanying the product.

Le point d'exclamation dans un triangle est un signe d'avertissement vous signale des instructions importantes accompagnant le produit.

See marking on bottom / back of product

Voir le marquage sur les bas / dos du produit



**Warning!** To reduce the risk of electrical shock, do not expose this apparatus to rain or moisture

**AVERTISSEMENT!** Pour réduire le risque de choc électrique, n'exposez pas cet appareil à la pluie ou à l'humidité.

Save these instructions

Conservez ces instructions

Compliance of this equipment is confirmed by the following label that is placed on the equipment:

Conformité de cet appareil est confirmé par le symbole suivant qui est placé sur l'équipement:



## USA & Canada Compliance

### FCC Part 15, Subpart B & IC Unintentional Emissions Interference Statement

This equipment has been tested and found to comply with the limits for a Class B digital device, pursuant to Part 15 of the FCC rules. These limits are designed to provide reasonable protection against harmful interference when the equipment is operated in a residential installation. This equipment generates uses and can radiate radio frequency energy and, if not installed and used in accordance with the instructions, may cause harmful interference to radio communications. However, there is no guarantee that interference will not occur in a particular installation. If this equipment does cause harmful interference to radio or television reception, which can be determined by turning the equipment off and on, the user is encouraged to try to correct the interference by one or more of the following measures:

- Reorient or relocate the receiving antenna.
- Increase the separation between the equipment and receiver.
- Connect the equipment into an outlet on a circuit different from that to which the receiver is connected.
- Consult the dealer or an experienced radio/TV technician for help.

This device complies with part 15 of the FCC rules and ISED's license-exempt RSSs. Operation is subject to the following two conditions: (1) This device may not cause harmful interference, and (2) this device must accept any interference received, including interference that may cause undesired operation.

Cet appareil est conforme à la section 15 des règles de la FCC et ISED's aux RSS exempts de licence d'ISED. Son utilisation est soumise aux deux conditions suivantes: (1) Cet appareil ne doit pas causer d'interférences nuisibles et (2) cet appareil doit accepter toutes les interférences reçues, y compris celles pouvant entraîner un fonctionnement non souhaité.

**IMPORTANT!** Any changes or modifications not expressly approved by the party responsible for compliance could void the user's authority to operate this equipment.

**IMPORTANT!** Tous les changements ou modifications pas expressément approuvés par la partie responsable de la conformité ont pu vider l'autorité de l'utilisateur pour actionner cet équipement.

Canada Warning Statement:

CAN ICES-3 (B)/NMB-3(B)

- This product meets the applicable Innovation, Science and Economic Development Canada technical specifications.
- Ce produit répond aux spécifications techniques applicables à l'innovation, Science et Développement économique Canada.

### FCC Part 15, Subpart C / RSS-247 Intentional Emissions Interference Statement

Compliance of this equipment is confirmed by the following certification numbers that are placed on the equipment:

**Notice:** The term "FCC ID:" and "IC:" before the certification number signifies that FCC and Industry Canada technical specifications were met.

CONTAINS FCC ID: A8TBM70ABCDEF GH

CONTAINS IC: 12246A-BM70BLES1F2

CONTAINS FCC ID: NKR-SWA12

CONTAINS IC: 4441A-SWA12

This equipment must be installed by qualified professionals or contractors in accordance with FCC Part 15.203 & IC RSS-247, Antenna Requirements. Do not use any antenna other than the one provided with the unit.

### **FCC Partie 15, sous-partie C / RSS-247 Déclaration volontaire des émissions interférences**

Conformité de cet appareil est confirmé par les chiffres de certification suivants qui sont placés sur l'équipement:

Avis: Le terme «FCC ID:» et "IC:" devant le numéro de certification signifie que les spécifications techniques de la FCC et d'Industrie Canada ont été respectées.

CONTAINS FCC ID: A8TBM70ABCDEF GH

CONTAINS IC: 12246A-BM70BLES1F2

CONTAINS FCC ID: NKR-SWA12

CONTAINS IC: 4441A-SWA12

Cet équipement doit être installé par des professionnels qualifiés ou entrepreneurs conformément aux normes FCC partie 15.203 & IC RSS-247, Exigences d'antenne. Ne pas utiliser une antenne autre que celui fourni avec l'appareil.

Cet émetteur ne doit pas être localisé ou fonctionner avec d'autres antennes ou transmetteurs. Les opérations dans la bande 5.15-5.25GHz sont limitées à l'utilisation à l'intérieur seulement.

### **RF Radiation Exposure Statement**

This equipment complies with FCC RF and IC radiation exposure limits set forth for an uncontrolled environment. This equipment should be installed and operated with a minimum distance of 20 centimeters between the radiator and your body or nearby persons.

### **Déclaration d'exposition aux radiations RF**

Cet équipement est conforme aux limites d'exposition aux rayonnements RF et IC de la FCC définies pour un environnement non contrôlé. Cet équipement doit être installé et utilisé avec une distance minimale de 20 centimètres entre le radiateur et votre corps ou des personnes proches.

### **Europe Compliance**

Compliance of this equipment is confirmed by the following logo that is placed on the product ID label that is placed on the bottom of the equipment. The full text of the EU Declaration of Conformity (DoC) is available on the regulatory web-page:





## Recycling

Wirepath Home Systems, LLC understands that a commitment to the environment is essential for a health life and sustainable growth for future generations. We are committed to supporting the environmental standards, laws, and directives that have been put in place by various communities and countries that deal with concerns for the environment. This commitment is represented by combining technological innovation with sound environmental business decisions.

## WEEE Compliance

Wirepath Home Systems, LLC is committed to meeting all requirements of the Waste Electrical and Electronic Equipment (WEEE) directive (2012/19/EC). The WEEE directive requires the manufacturers of electrical and electronic equipment who sell in EU countries: (1) label their equipment to notify customers that it needs to be recycled, and (2) provide a way for their products to be appropriately disposed of or recycled at the end of their product lifespan. For collection or recycling of Wirepath Home Systems, LLC products, please contact your local Wirepath Home Systems, LLC representative or dealer.



## Australia & New Zealand Compliance

Compliance of this equipment is confirmed by the following logo that is placed on the product ID label that is placed on the bottom of the equipment.



**CONTENTS**

REGULATORY COMPLIANCE & SAFETY INFORMATION ..... 2

WELCOME TO EPISODE® ..... 8

FEATURES..... 8

INSTALLATION..... 9

BACK PANEL SUBWOOFER HOOK-UP AND CONTROLS..... 10

GETTING CONNECTED..... 13

LINE-LEVEL/UNBALANCED INPUTS..... 13

UNBALANCED HI LEVEL INPUTS..... 14

BALANCED INPUTS..... 15

12V DC TRIGGER..... 16

IP CONTROL..... 16

EPISODE MEGA SUBWOOFER CONTROL AND SETUP APPLICATION..... 18

FINE TUNING..... 20

INSTALLING AND REMOVING THE GRILLES..... 21

CARPET SPIKES..... 21

CLEANING ..... 21

SPECIFICATIONS..... 22

TROUBLESHOOTING..... 24

WARRANTY..... 24

CONTACTING TECHNICAL SUPPORT..... 24

## WELCOME TO EPISODE®

Episode is one of the most highly regarded brands of speakers available today. We appreciate your business and we stand committed to providing our customers with the highest degree of quality and service in the industry. Episode subwoofers are a superb choice for bass reinforcement of almost every type of audio system. They have been designed with advanced technology components that accurately reproduce low frequencies in all types of music and movies. For optimum system performance, we recommend pairing them with our acclaimed Episode loudspeakers.

## FEATURES

### World-Class BASH® Hybrid Amplifier Technology

Incorporating the latest BASH amplifier technology to maximize performance while generating little heat.

### Episode MEGA Control App

Through the use of advanced digital signal processing, most of the standard back panel analog adjustments have been incorporated into an easy, accurate app.

The app allows you to set up and adjust the Volume, Pre-set EQ Modes, Phase control, Delay, Auto Off/On, Low Pass, Parametric EQ, and Automatic Equalization.

**NOTE:** A Bluetooth 4.0, low-energy, iOS or Android device is required for proper setup, control, and use of the app.



### High-Quality / Furniture-Grade Cabinets

Attractive, furniture-quality cabinets provide the ultimate in rigidity and sound clarity.

- S Series available in attractive matte black finish.
- D Series available in polished gloss black or walnut wood veneer finish.

### Automatic Equalization

The built-in, high-performance DSP and the Episode MEGA app allow for simplified and precise equalization corrections of the subwoofer, to your position in the room. The app allows for multiple subwoofers in the same room, or home, to be independently equalized and controlled.

### Inputs

- **Unbalanced:** Features stereo RCA line-level inputs for two-channel applications. For home theater use, the right RCA unbalanced input also serves as an LFE (low-frequency effects) input with a direct connection from a receiver or processor.
- **High Level:** For versatility, there are gold-plated, five-way binding-post inputs for speaker-level connections.
- **Wireless:** All MEGA Series subwoofers have a built-in wireless receiver that is compatible with the optional Episode Subwoofer Wireless Transmitter (ES-SUB-WIFI-TX-MEGA). Connect the wireless transmitter to your AVR / processor subwoofer / LFE output, pair the transmitter to the subwoofer(s) in the system, and the signal is reliably sent to the subwoofer(s). Up to three subwoofers can be paired to a single transmitter.
- **Balanced:** Exclusive to the MEGA D Series subwoofers, XLR balanced inputs are provided for clean, accurate audio from receivers or processors with balanced outputs.

### Remote Operation

Both the MEGA S Series and MEGA D Series offer an Ethernet connection for IP control with many home automation platforms. Currently supported drivers and IP control documentation can be found on the associated MEGA subwoofer product page. IP control allows for basic functionality and product status.

The MEGA D Series subwoofers also offer a dedicated 12V trigger for remote on/off functionality, without the need for IP connectivity.





## INSTALLATION

Subwoofer placement affects the audio performance that you receive. All rooms are different, but the strongest output will likely occur if the subwoofer is placed on the floor, in a corner of the room on the same wall as the front channel speakers. This is known as the boundary effect and emphasizes certain bass frequencies; however, it cancels other bass frequencies.

Some listeners will find this to be the best-sounding result, while others may find it overly “boomy” or muddy. Experiment with the placement options available to you and follow the fine-tuning instructions on page 12 of this manual.

Note for corner placement with the D Series (Dual Driver): For optimal performance, we recommend that the subwoofer be placed at a 45° angle and at least 30cm (12”) from the corner.

For ultimate flexibility in placement, use the optional Episode MEGA Subwoofer Wireless Transmitter (ES-SUB-WIFI-TX-MEGA).

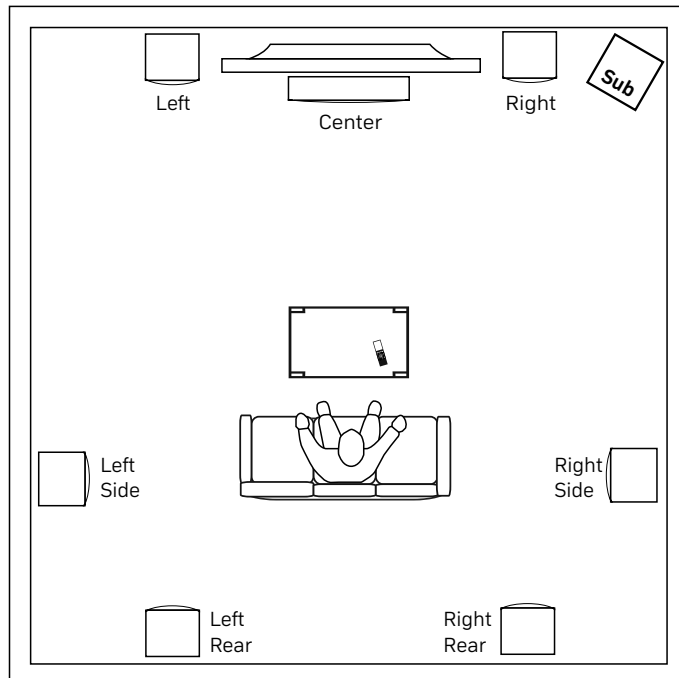

## BACK PANEL SUBWOOFER HOOK-UP AND CONTROLS

Your Episode subwoofer is suited to match nearly every home theater or music application.

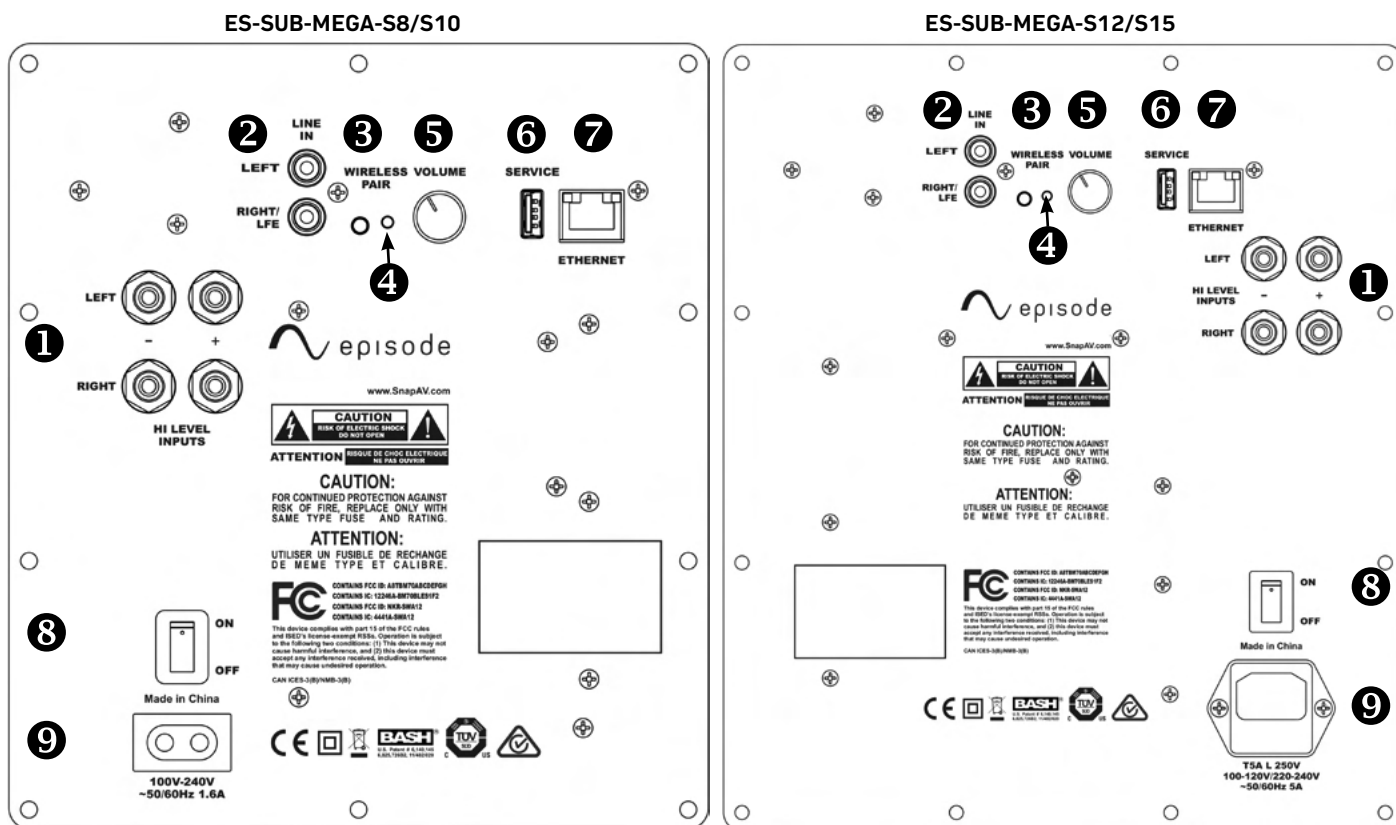

1. **HI LEVEL INPUTS:** Gold-plated, five-way, binding post inputs for speaker-level connections.
2. **UNBALANCED LINE IN:** For unbalanced, stereo RCA line-level connections. The RIGHT RCA unbalanced input doubles as an LFE (low-frequency effects) input for a direct connection from the receiver or processor.
3. **WIRELESS PAIRING/RESET BUTTON:** Multi-function button with the following attributes:
  - a. **Manual Power ON:** Short press on the button: LED shows powering up process described below (section 4. Status LED).
  - b. **Wireless Pairing:** Press and hold the button until the LED starts blinking slowly (200 ms on/off @ 10 seconds). Release the button subwoofer now in wireless pairing mode. The LED will continue to blink slowly for 1 min, and goes OFF if pairing is not successful. Wireless pairing requires the Episode Subwoofer Wireless Transmitter (ES-SUB-WIFI-TX-MEGA), sold separately. See the ES-SUB-WIFI-TX-MEGA installation manual for complete pairing set-up guide.
  - c. **Factory Reset:** Press and hold the button until the LED starts blinking quickly (100ms on/off @ 10-15 seconds). If the button is released, subwoofer executes factory reset and restarts.
  - d. **Button Cancel:** To cancel a Button Press without changing anything, Press and hold the button until the LED stops flashing, 15+ seconds. Once the LED goes out, release the button.
4. **STATUS LED:** Multi-function LED attributes:
  - a. **AC Power Up:** LED blinks slowly 5 times (200 ms on/off).
  - b. **Audio Signal Present:** One additional blink after AC Power Up, if an audio signal is present or with an Ethernet / 12v trigger command to turn on.
  - c. **Adjustment Confirmation:** LED flashes slowly and continuously (200ms on/off) while making adjustments via the Episode MEGA Subwoofer app.
  - d. **Wireless Pairing Assistance:** For use and guidance when pairing to the optional wireless transmitter (ES-SUB-WIFI-TX-MEGA).
  - e. **Product On:** LED is OFF.
5. **VOLUME:** Controls overall output for the subwoofer.
6. **SERVICE:** USB port for future firmware updates.

- 7. **ETHERNET:** Allows for IP control. Currently supported drivers and IP control protocol documentation can be found on the associated MEGA subwoofer product page.
- 8. **MAIN POWER SWITCH:** Primary power On/Off. Auto-power On/Off setting available through app
- 9. **AC INLET:** Standard 2-prong IEC power jack.

ES-SUB-MEGA-D8

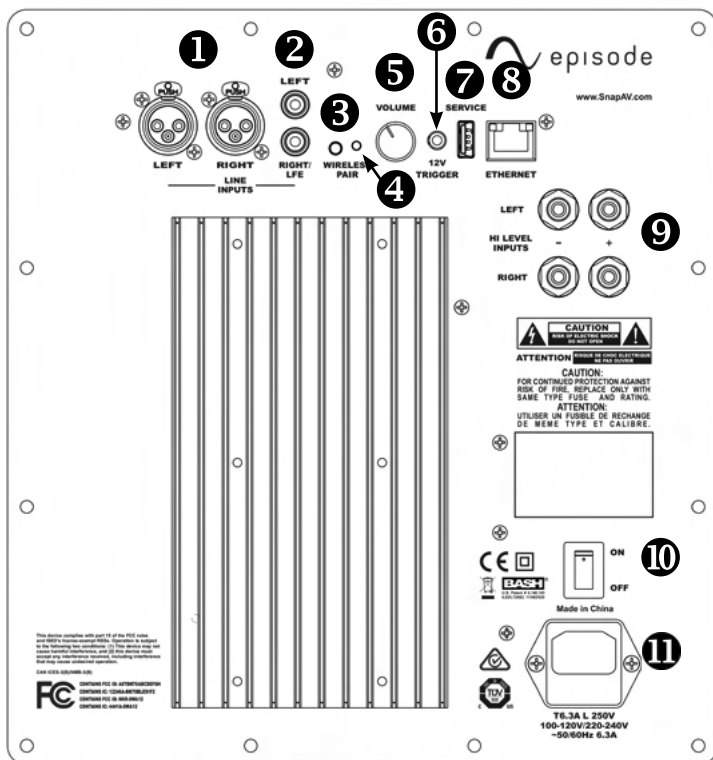

ES-SUB-MEGA-D10/D12

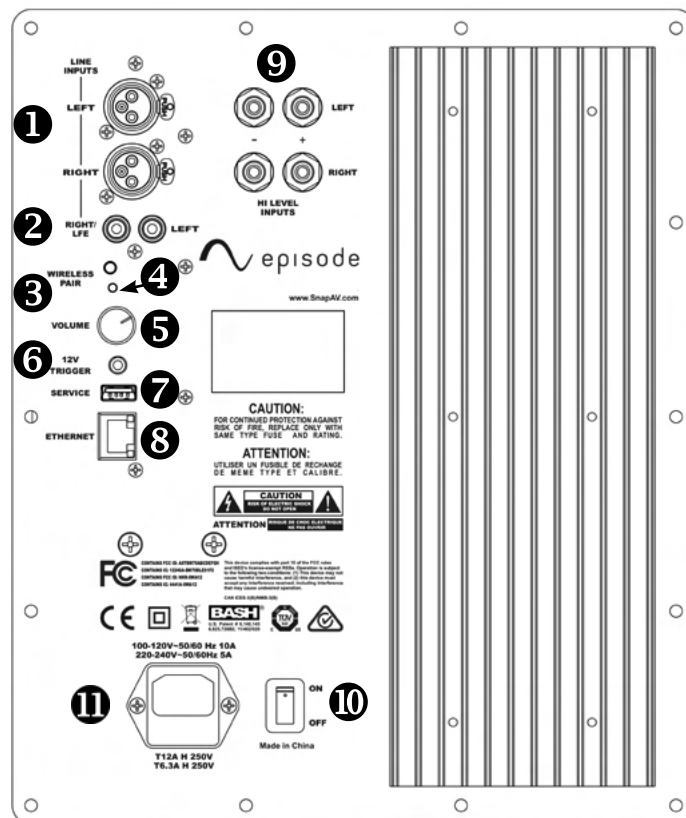

- 1. **BALANCED LINE IN:** XLR balanced inputs are provided to support receivers or processors with balanced outputs.
- 2. **UNBALANCED LINE IN:** For unbalanced, stereo RCA line-level connections. The RIGHT RCA unbalanced input doubles as an LFE (low-frequency effects) input for a direct connection from the receiver or processor.
- 3. **WIRELESS PAIRING/RESET BUTTON:** Multi-function button with the following attributes:
  - a. **Manual Power ON:** Short press on the button: LED shows powering up process (see section 4. Status LED).
  - b. **Wireless Pairing:** Press and hold the button until the LED starts blinking slowly (200 ms on/off @ 10 seconds). Release the button subwoofer now in wireless pairing mode. The LED will continue to blink slowly for 1 min, and goes OFF if pairing is not successful.  
Wireless pairing requires the Episode Subwoofer Wireless Transmitter (ES-SUB-WIFI-TX-MEGA), sold separately. See the ES-SUB-WIFI-TX-MEGA installation manual for complete pairing set-up guide.
  - c. **Factory Reset:** Press and hold the button until the LED starts blinking quickly (100ms on/off - @ 10 to 15 seconds). If the button is released, subwoofer executes factory reset and restarts.
  - d. **Button Cancel:** To cancel a Button Press without changing anything, Press and hold the button until the LED stops flashing, 15+ seconds. Once the LED goes out, release the button.
- 4. **STATUS LED:** Multi-function LED attributes:
  - a. **AC Power Up:** LED blinks slowly 5 times (200 ms on/off).
  - b. **Audio Signal Present:** One additional blink after AC Power Up, if an audio signal is present or with an Ethernet / 12v trigger command to turn on.
  - c. **Adjustment Confirmation:** LED flashes slowly and continuously (200ms on/off) while making adjustments via the Episode MEGA Subwoofer app.
  - d. **Wireless Pairing Assistance:** For use and guidance when pairing to the optional wireless transmitter (ES-SUB-WIFI-TX-MEGA).
  - e. **Product On:** LED is OFF.

5. **VOLUME:** Controls overall output for the subwoofer.
6. **12V TRIGGER:** For remote on/off functionality without the need of IP connectivity.
7. **SERVICE:** USB port for future firmware updates.
8. **ETHERNET:** Allows for IP control. Currently supported drivers and IP control protocol documentation can be found on the associated MEGA subwoofer product page.
9. **HI LEVEL INPUTS:** Gold-plated, five-way, binding post inputs for speaker-level connections.
10. **MAIN POWER SWITCH:** Primary power On/Off. Auto-power On/Off setting available through app
11. **AC INLET:** Standard 2-prong IEC power jack.

**NOTE:** The ES-SUB-MEGA-D10 and D12 ship without an AC Power Fuse inserted. Initial use requires the appropriate fuse selection and insertion into the fuse compartment, at the bottom of the AC Inlet.

For 100-120V (50/60Hz) use the supplied T12A H250V fuse.

For 220-240V (50/60Hz) use the supplied T6.3A H250V fuse.

Always use an appropriate IEC power cord to support the respective regional power utility.

(Fuses and detailed fuse installation guide included with product accessory package.)

## GETTING CONNECTED

Episode MEGA powered subwoofers are among the most flexible on the market today and can be configured for use in many different applications, as shown in the figures below.

- For line level connections, use high-quality RCA cables that feature low-impedance shielding and high-quality connectors.
- Use two-conductor loudspeaker wire for high-level connections to the subwoofer.

**NOTE: Do not** connect wiring to more than one set of left/right inputs simultaneously. **Example:** If using loudspeaker-level inputs, **do not** connect RCA cables and/or XLR cables to the subwoofer at the same time.

## LINE-LEVEL/UNBALANCED INPUTS

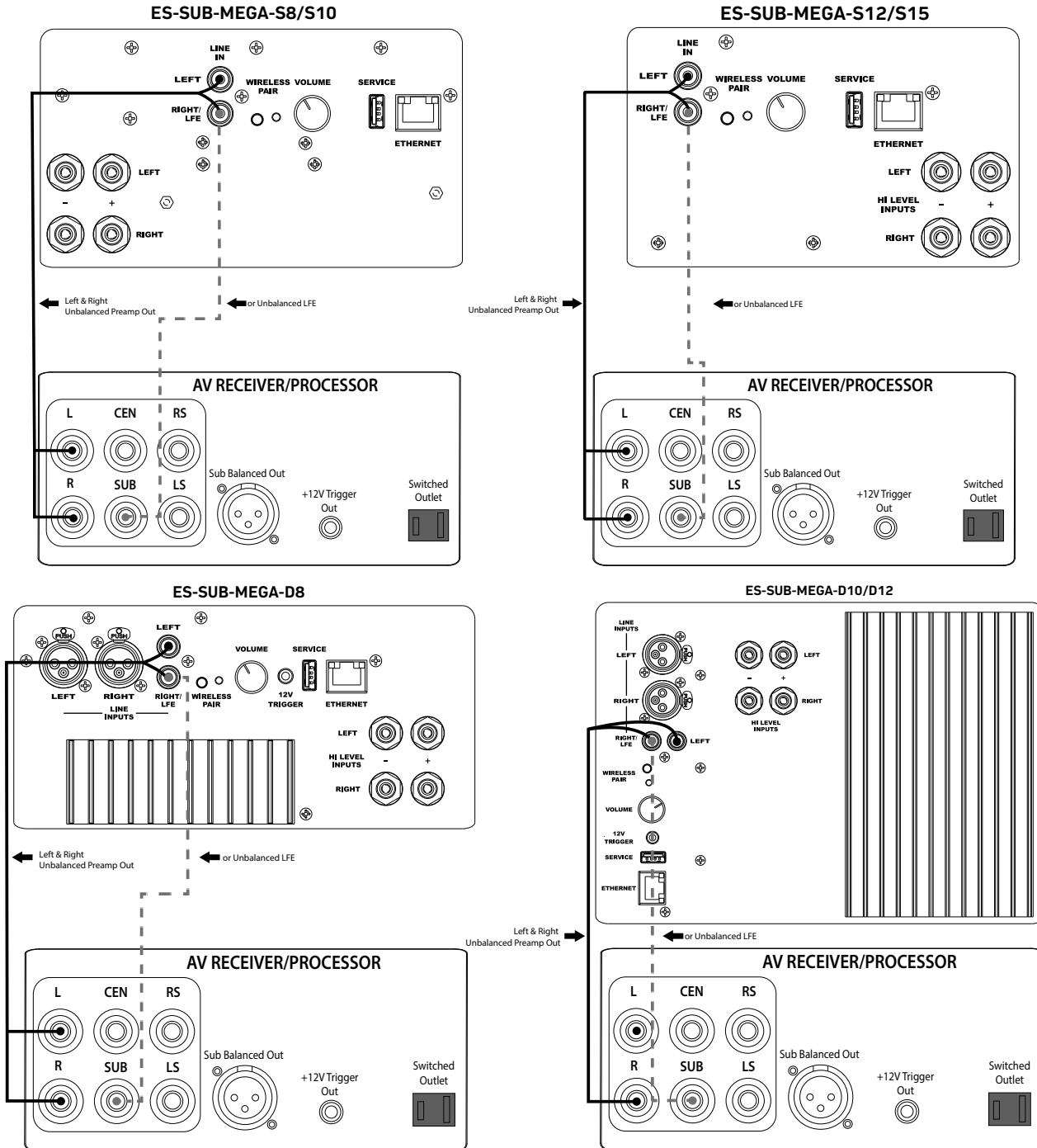

# UNBALANCED HI LEVEL INPUTS

**ES-SUB-MEGA-S8/S10**

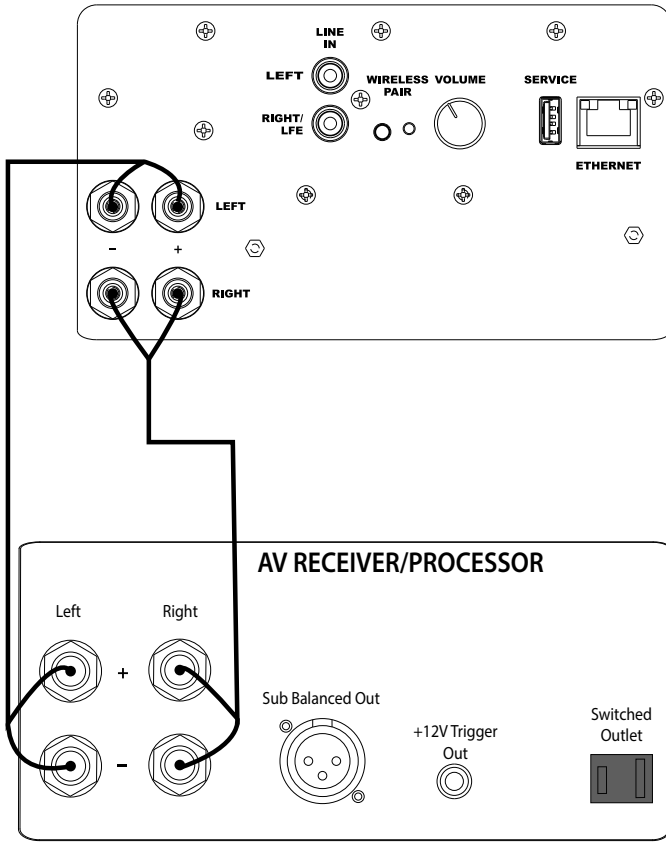

**ES-SUB-MEGA-S12/S15**

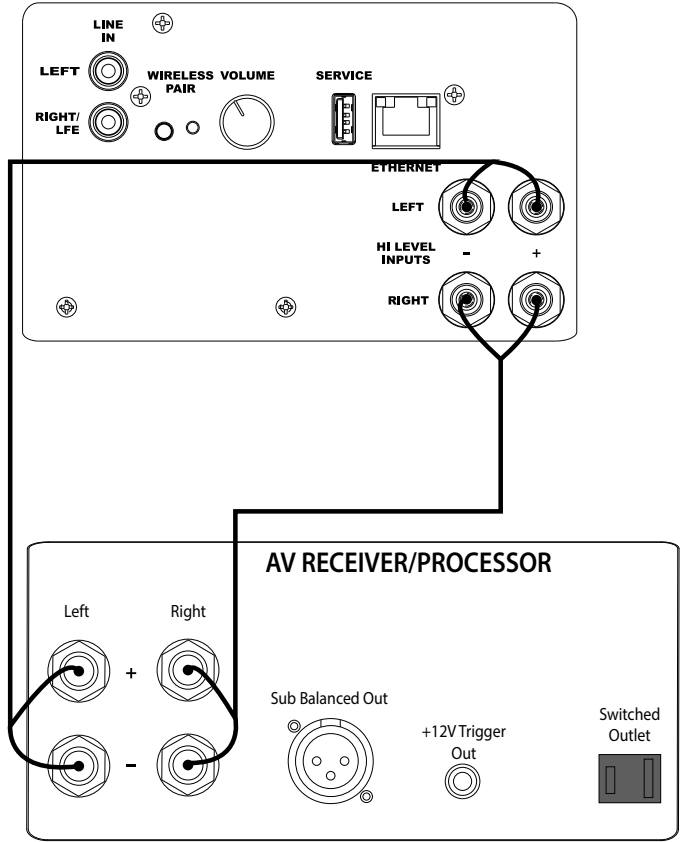

**ES-SUB-MEGA-D8**

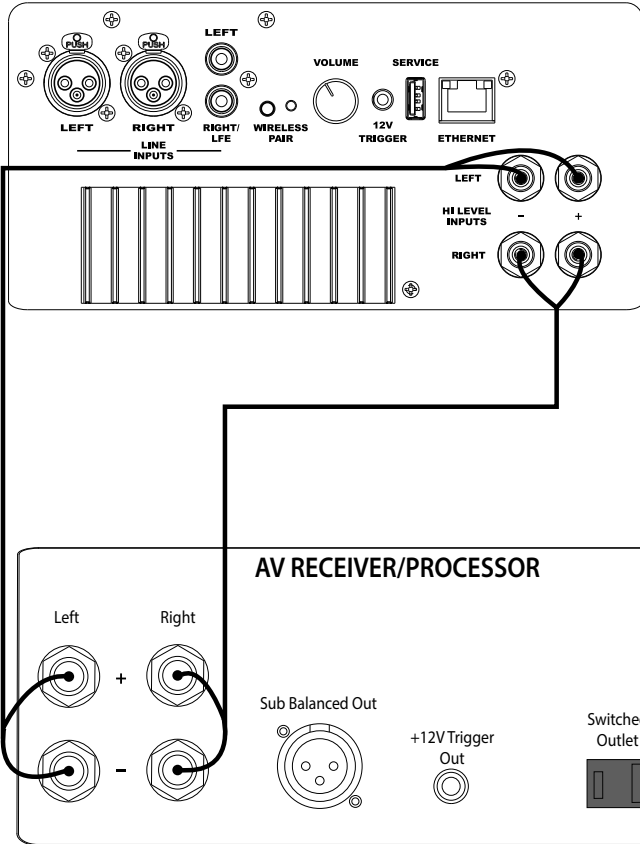

**ES-SUB-MEGA-D10/D12**

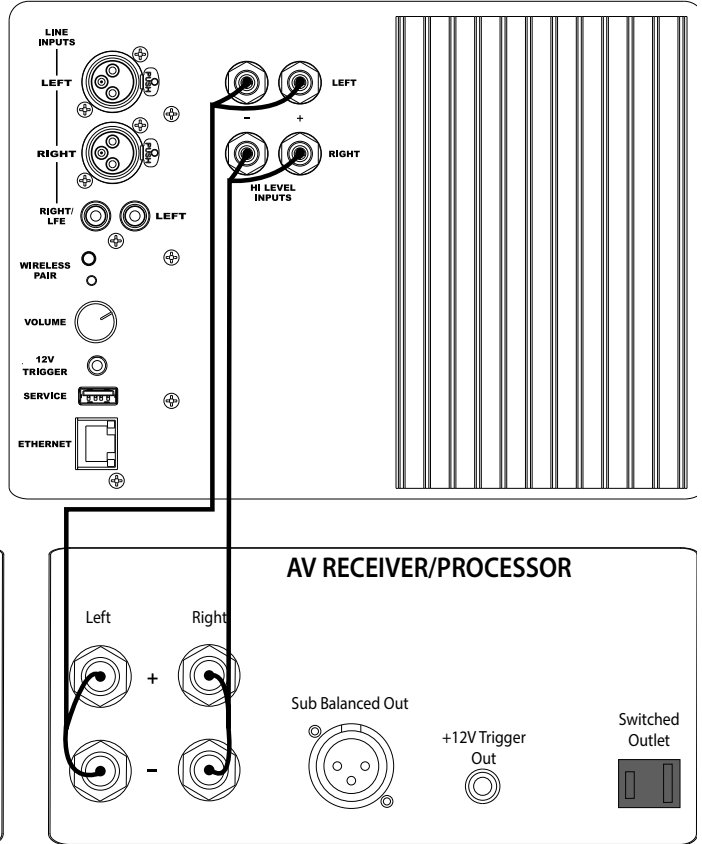

## BALANCED INPUTS

Using Left and Right balanced XLR connections:

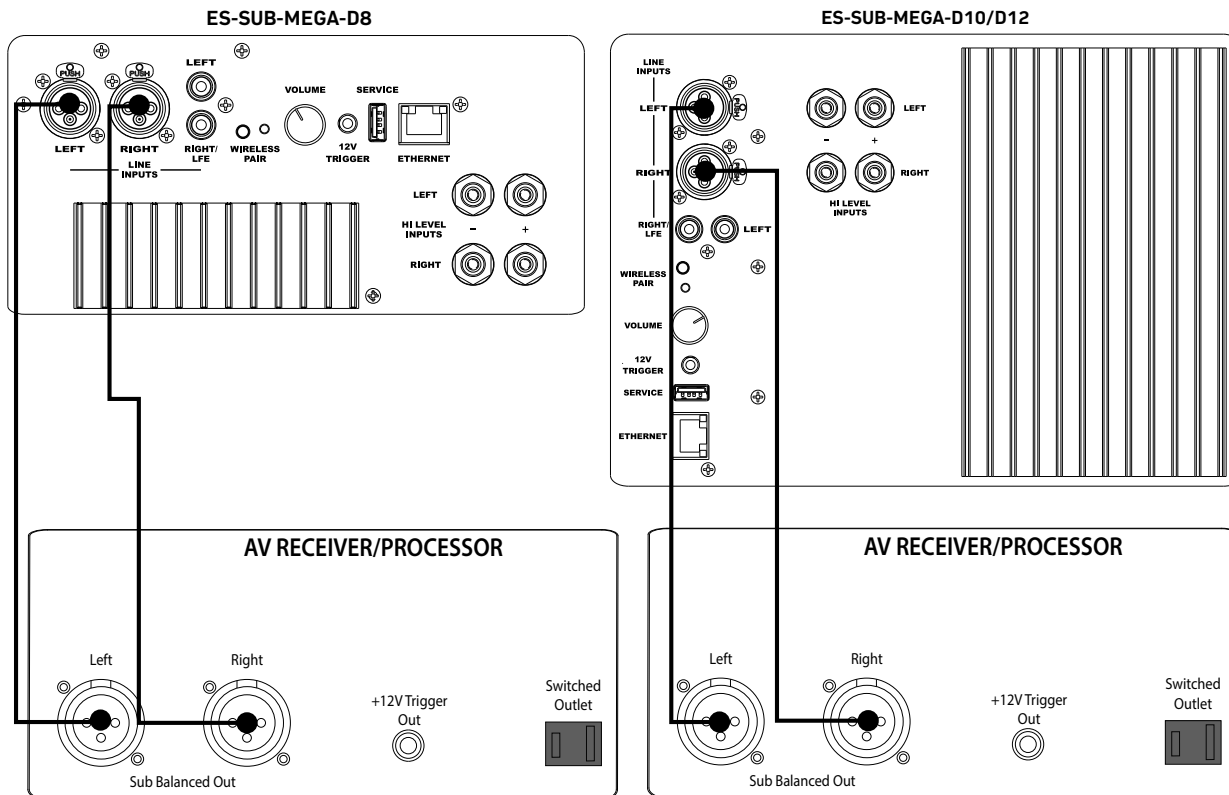

Using an LFE balanced connection:

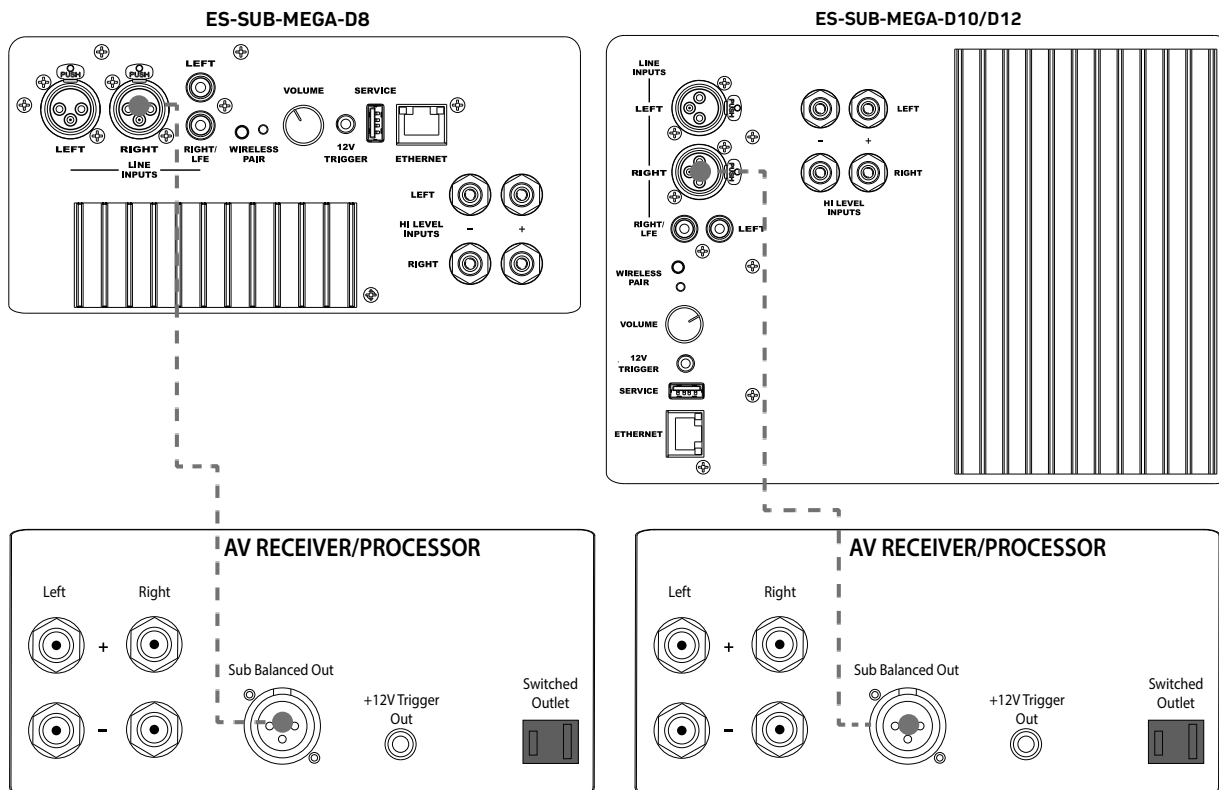

## 12V DC TRIGGER

The D Series MEGA subwoofers are equipped with a 12V trigger input to turn the amplifier on/off, reducing power consumption when not in use. When this input receives a 12V signal, the amplifier turns on; when the signal goes away, the amplifier turns off.

- Connect the 12V trigger output of the AV receiver to the 12V trigger input of the D Series subwoofer using a high-quality 3.5 mm (1/8") mono cable.
- If the receiver does not have a 12V trigger output, a 12V power supply plugged into a switched outlet on the receiver provides the same functionality.

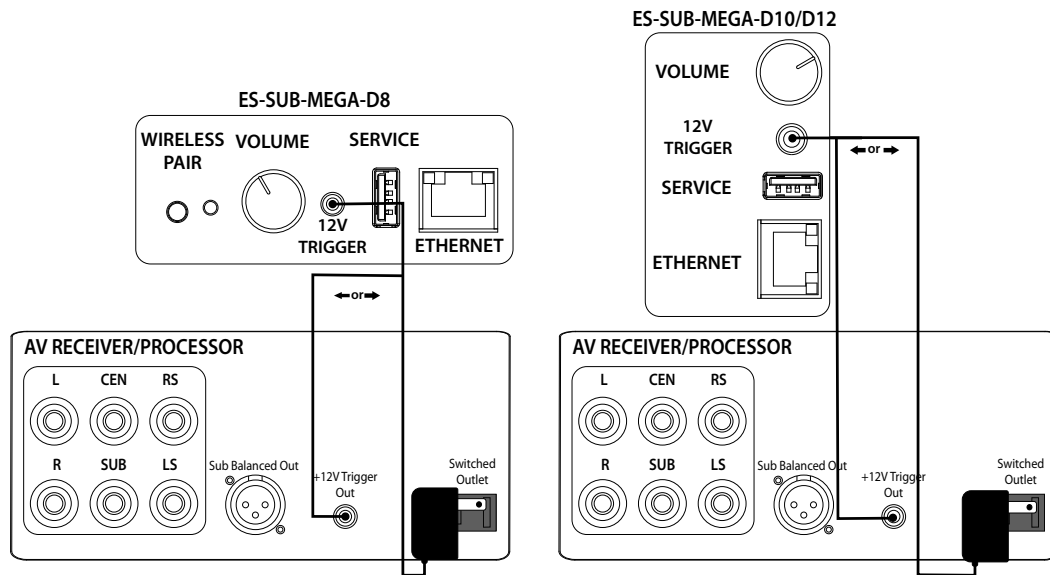

## 12V DC TRIGGER PIN CONFIGURATION

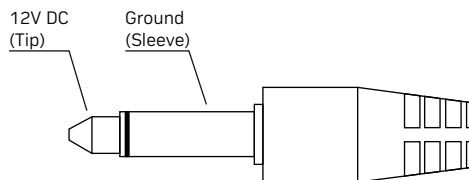

## IP CONTROL

Both S Series and D Series MEGA subwoofers are equipped with Ethernet ports for IP control. Control drivers for many popular control systems are available on the corresponding product page of the website.

The local network interface can be accessed with the following URLs:

- <http://MEGA-S8>
- <http://MEGA-S10>
- <http://MEGA-S12>
- <http://MEGA-S15>
- <http://MEGA-D8>
- <http://MEGA-D10>
- <http://MEGA-D12>



## DEFAULT LOGIN

All models follow the same log-in process for accessing the Local interface network settings:

**Default User Name:** admin

**Default Password:** The Service Tag number, found on the back of the subwoofer.

**NOTE:** The above log-in is reinstated if product is reset to default settings.

## LOCAL INTERFACE ADJUSTMENTS

The Local interface will show basic product information, such as product name, model, MAC address, firmware version, and Service Tag number.

Local interface adjustments include product name change, IP settings, and password change.

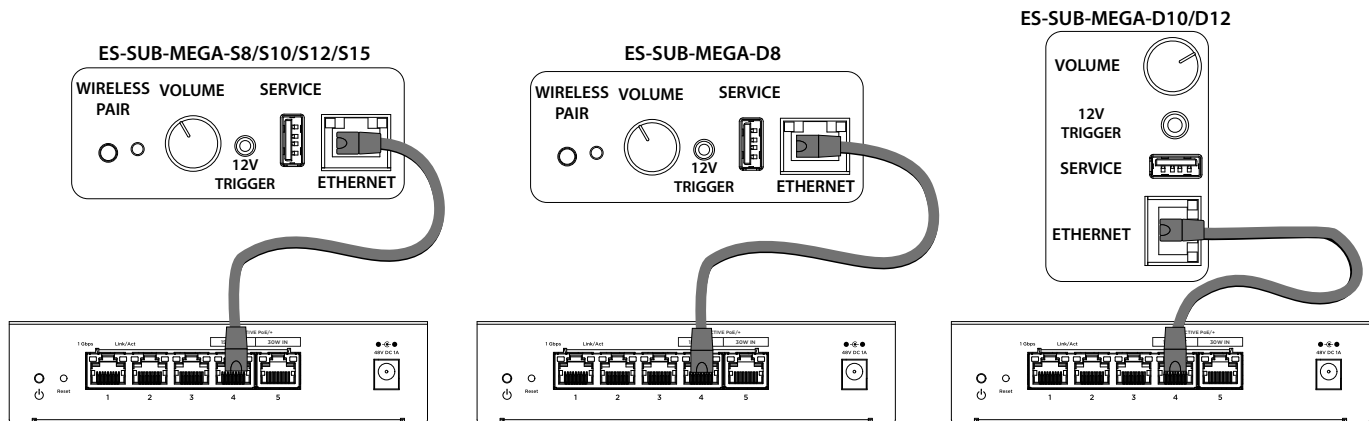

## EPISODE MEGA SUBWOOFER CONTROL AND SETUP APPLICATION

Your Episode MEGA Subwoofer app allows you to fine-tune the output using your Android or iOS device. Download the app from the App Store or Google Play Store.

Knobs and switches have been replaced by a digital signal processor (DSP), which enables you to make precise adjustments to your subwoofer. You can adjust individual parameters such as volume, phase, and cutoff frequency, or use automatic calibration through the app.

A Bluetooth 4.0 low-energy iOS or Android device is required for setup and operation of your Episode MEGA subwoofer. If your mobile device asks for a 4-digit code to pair to the subwoofer, use **0000**.

### SETUP

Setup mode allows you to adjust various parameters so your subwoofer sounds the way you like it.

### PRESETS/VOLUME

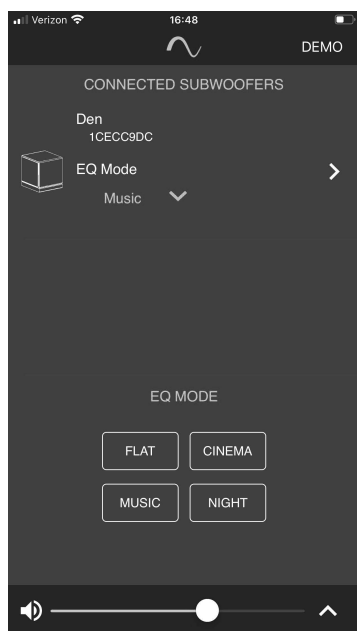

**EQ Mode:** The Episode MEGA subwoofer comes with four sound presets.

- a. **Normal** is the setting used for most applications.
- b. **Music** adds emphasis to the lower bass range
- c. **Cinema** boosts the frequencies around 50 Hz, giving the bass a more dramatic effect.
- d. **Night** reduces the maximum volume, so you can still use your subwoofer without annoying the rest of the household.

**Volume:** Adjust the volume slider so your subwoofer's output is balanced with the volume of your stereo/surround speakers. If you set your subwoofer's output too high, it blurs the room's sound image, which isn't desirable.

### Phase

Sit in the best listening spot of the room while making this adjustment. Pick a song with substantial bass, and pay attention to it as you adjust the slider. While adjusting, make sure the bass sounds musical and not too punchy or flat.

### Delay

The Delay parameter allows you to delay playback of the Episode MEGA subwoofer's audio signal. Delay is typically used if the subwoofer is physically closer to you than the rest of your speakers. Setting the delay to 1 millisecond is the same as moving the subwoofer approximately 33cm (13") away from your listening position. Setting the delay to 20 milliseconds would be like moving the sub 6.6m (21.5') away.

If your amplifier or surround sound receiver has an automatic calibration feature, it automatically sets the delay time internally. This should keep you from having to adjust the delay on your subwoofer.

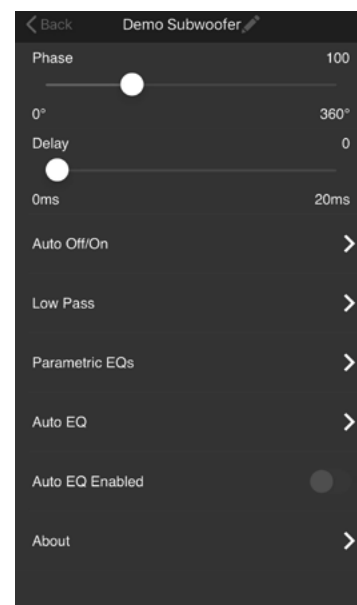

### Auto On/Off

Your subwoofer is set to **Auto On**, by default. This turns your subwoofer on when a bass signal is received through any of the inputs. If it does not detect a signal for 15 minutes, the subwoofer goes into standby mode. Depending on the amplifier being used, you can adjust the sensitivity between 1–10mV.

Two options available - Auto Off/On via signal or Ethernet.

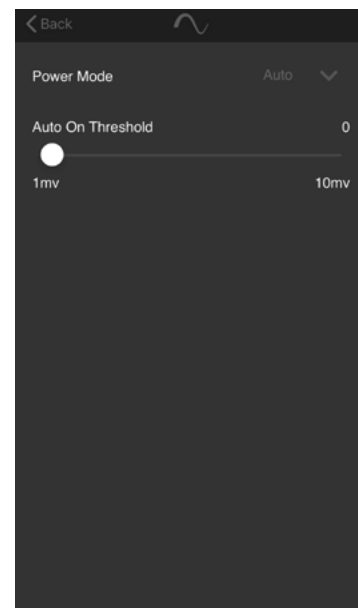

### Low Pass

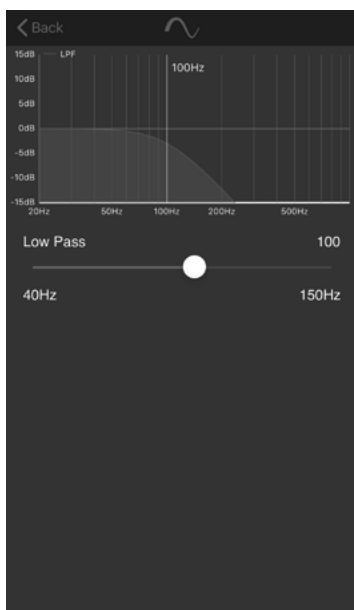

Sets the frequency at which the Episode MEGA subwoofer starts to perform. You can adjust the cutoff frequency by adjusting the slider. You want to match your stereo/surround speakers so the subwoofer can blend in seamlessly.

## PARAMETRIC EQUALIZER

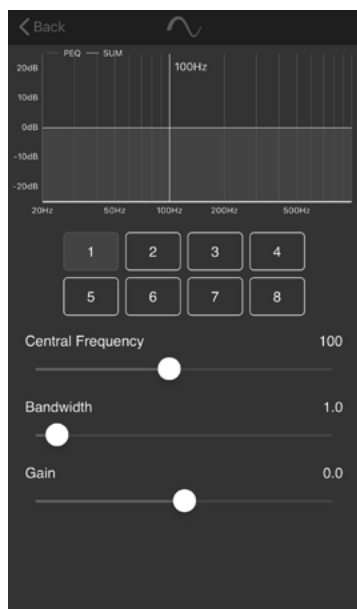

The Episode MEGA Subwoofer app allows you to adjust the center frequency, bandwidth and gain with the Parametric Equalizer. To key in the perfect sound, find an audio test disc to play. Many audio test disc options are available online.

Set your **Central Frequency** to the level listed on your audio test disc. With your audio test disc playing, listen for any unnatural-sounding bass notes. Slowly reduce the **Bandwidth** and **Gain** if the bass notes sound too loud. Increase them if the bass notes sound too soft. Your goal is to match the loudness of your other frequencies.

To boost a particular frequency range, increase the **Bandwidth** and slowly adjust the **Gain**. Listen closely to make sure you don't create any unnatural-sounding effects.

## AUTO EQ

Your Episode MEGA subwoofer is equipped with an easy-to-use automatic calibration feature, which activates your subwoofer through the app. The app instructs your subwoofer to play a measurement signal and uses your smartphone's built-in microphone to display the measurement curve, within range. Auto EQ will calibrate the subwoofer for the environment's measurements, including the microphone and sound reproduction chain. Then it measures the room's actual frequency response.

**Follow the instructions in the app for a successful calibration.** First, the app asks you to hold your smartphone near the front of the Episode MEGA subwoofer. After a short frequency sweep the app will ask you to move to your listening position and run a second frequency sweep. With both measurements complete, the app will show the corrected sound curve tailored to your room.

The equalization curve is kept in memory until you overwrite it with a new measurement.

You can turn Auto EQ off or on at any time from the **SETUP** menu.

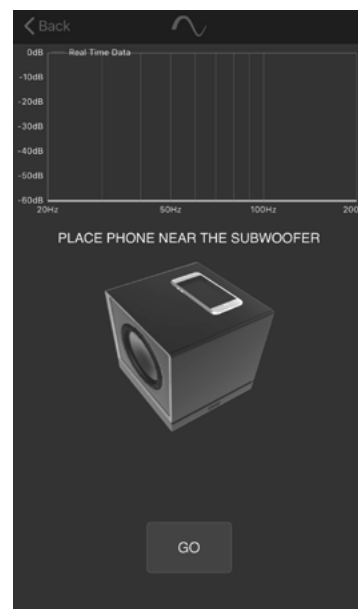

## FINE TUNING

After making all the connections and calibrating the sub via the Episode MEGA Subwoofer app, you can still perform some fine tuning using the following guidelines:

**NOTE:** When using an AV receiver with an automatic calibration system, perform the Episode MEGA subwoofer auto calibration via the app first, and then run the AV receiver's full-room calibration. **Then, perform the following steps if needed:**

1. Ensure the subwoofer is plugged in.
2. Play a movie scene or music track and set the system volume to an average level. Listen to the bass level from your favorite listening position and adjust the VOLUME control as desired.
3. If deeper bass is desired, adjust the LOW PASS control toward the lower frequencies. Experiment with different frequency settings until you find one that sounds best.
4. Continue listening to your favorite music and movie sources using the settings chosen for volume and crossover. Now, try experimenting with the PHASE and DELAY until you find the best setting for the installation. Depending on

your subwoofer's placement, the bass may sound louder or deeper when the phase and delay have been optimized. In some cases, adjusting PHASE and DELAY will make no discernible difference.

## **INSTALLING AND REMOVING THE GRILLES**

To remove the grilles, gently pull at the corners of the grille frame to separate the grille from the baffle of the subwoofer. To install the grille, start in one top corner and gently press the grille frame in around the front baffle, pushing it in at each of the remaining three recessed holes.

## **CARPET SPIKES**

Each MEGA subwoofer includes a set of "carpet spikes" that can be installed on the bottom of the subwoofer, when placing the subwoofer on a carpeted surface.

## **CLEANING**

Use a soft cloth or paper towel to clean the cabinet. The grille is best cleaned by brushing it off with a lint-free cloth.

## SPECIFICATIONS

### Single-Driver / S Series Models

	ES-SUB-MEGA-S8	ES-SUB-MEGA- S10	ES-SUB-MEGA- S12	ES-SUB-MEGA- S15
<b>Frequency Response</b>	30-250 Hz	23-250 Hz	22.5-250 Hz	20-250 Hz
<b>Crossover Frequency</b>	40-150 HZ	40-150 HZ	40-150 HZ	40-150 HZ
<b>Power Peak</b>	240W	400W	1000W	1300W
<b>Power RMS</b>	120W	200W	500W	650W
<b>SPL +/- 3 dB (ANSI/CTA-2010 SPL Measurement at 2 m)</b>	90 dB	91.5 dB	92 dB	94 dB
<b>Woofers</b>	8" Single Active	10" Single Active	12" Single Active	15" Single Active
<b>Driver Material</b>	Kevlar Reinforced Paper	Kevlar Reinforced Paper	Kevlar Reinforced Paper	Kevlar Reinforced Paper
<b>Voice Coil</b>	2"	2"	2.5"	3"
<b>Speaker Grille</b>	Cloth	Cloth	Cloth	Cloth
<b>Back Panel Adjustments</b>	Volume, BLE Pairing/ Reset	Volume, BLE Pairing/ Reset	Volume, BLE Pairing/ Reset	Volume, BLE Pairing/ Reset
<b>Back Panel Audio Inputs</b>	Unbalanced Line Level (RCA), High Level (Speaker)	Unbalanced Line Level (RCA), High Level (Speaker)	Unbalanced Line Level (RCA), High Level (Speaker)	Unbalanced Line Level (RCA), High Level (Speaker)
<b>Additional Back Panel Connections</b>	Ethernet/RJ45 (Control) USB (Service/Update)	Ethernet/RJ45 (Control) USB (Service/Update)	Ethernet/RJ45 (Control) USB (Service/Update)	Ethernet/RJ45 (Control) USB (Service/Update)
<b>App Controllable</b>	YES - Bluetooth 4.0 Low Energy iOS or Android device.	YES - Bluetooth 4.0 Low Energy iOS or Android device.	YES - Bluetooth 4.0 Low Energy iOS or Android device.	YES - Bluetooth 4.0 Low Energy iOS or Android device.
<b>Adjustments via App</b>	Volume, Preset EQ Modes, Low Pass, Phase, Parametric EQ, Delay, Auto On/ Off, Automatic EQ/ Calibration	Volume, Preset EQ Modes, Low Pass, Phase, Parametric EQ, Delay, Auto On/ Off, Automatic EQ/ Calibration	Volume, Preset EQ Modes, Low Pass, Phase, Parametric EQ, Delay, Auto On/ Off, Automatic EQ/ Calibration	Volume, Preset EQ Modes, Low Pass, Phase, Parametric EQ, Delay, Auto On/ Off, Automatic EQ/ Calibration
<b>Wireless</b>	Built-in wireless receiver. Compatible with ES-SUB-WIFI-TX- MEGA transmitter (sold separately).	Built-in wireless receiver. Compatible with ES-SUB-WIFI-TX- MEGA transmitter (sold separately).	Built-in wireless receiver. Compatible with ES-SUB-WIFI-TX- MEGA transmitter (sold separately).	Built-in wireless receiver. Compatible with ES-SUB-WIFI-TX- MEGA transmitter (sold separately).
<b>IP Control via RJ45</b>	Yes	Yes	Yes	Yes
<b>12v Trigger Input</b>	No	No	No	No
<b>Cabinet Color/Finish</b>	Matte Black	Matte Black	Matte Black	Matte Black
<b>Feet</b>	Non-slip rubber & Carpet spikes	Non-slip rubber & Carpet spikes	Non-slip rubber & Carpet spikes	Non-slip rubber & Carpet spikes
<b>Dimensions (W x H x D)</b>	360.68 mm (14.2") x 320.04 mm (12.6") x 322.58 mm (12.7")	429.26 mm (16.9") x 396.24 mm (15.6") x 396.24 mm (15.6")	457.20 mm (18") x 416.56 mm (16.4") x 416.56 mm (16.4")	497.84 mm (19.6") x 459.74 mm (18.1") x 467.36 mm (18.4")
<b>Power Consumption</b>	IEC 2 Prong 100-240v, 50-60Hz	IEC 2 Prong 100-120v / 220-240v, 50-60Hz	IEC 2 Prong 100-120v / 220-240v, 50-60Hz	IEC 2 Prong 100-120v / 220-240v, 50-60Hz
<b>Sold As</b>	Each	Each	Each	Each
<b>Weight</b>	11.4 kg / 25.1 lbs	17.7 kg / 38.9 lbs	20.1 kg / 44.3 lbs	28.6 kg / 62.9 lbs

**NOTE:** MEGA subwoofer are built using some of the finest components and materials - as such, these are heavy. Two person lift is highly recommended.

**Dual Driver Models / D Series Models**

	<b>ES-SUB-MEGA-D8</b>	<b>ES-SUB-MEGA-D10</b>	<b>ES-SUB-MEGA-D12</b>
<b>Frequency Response</b>	20-250 Hz	18-250 Hz	17-250 Hz
<b>Crossover Frequency</b>	40-150 HZ	40-150 HZ	40-150 HZ
<b>Power Peak</b>	1300W	1600W	2000W
<b>Power RMS</b>	650W	800W	1000W
<b>SPL +/- 3 dB (ANSI/CTA-2010 SPL Measurement at 2 m)</b>	92 dB	94 dB	96 dB
<b>Woofers</b>	8" Dual Active	10" Dual Active	12" Dual Active
<b>Driver Material</b>	Aluminum Reinforced Paper	Aluminum Reinforced Paper	Aluminum Reinforced Paper
<b>Voice Coil</b>	1.5"	2.5"	2.5"
<b>Speaker Grille</b>	Cloth	Cloth	Cloth
<b>Back Panel Adjustments</b>	Volume, BLE Pairing/ Reset	Volume, BLE Pairing/ Reset	Volume, BLE Pairing/ Reset
<b>Back Panel Audio Inputs</b>	Balanced (XLR), Unbalanced Line Level (RCA), High Level (Speaker)	Balanced (XLR), Unbalanced Line Level (RCA), High Level (Speaker)	Balanced (XLR), Unbalanced Line Level (RCA), High Level (Speaker)
<b>Additional Back Panel Connections</b>	Ethernet/RJ45 (Control) USB (Service/Update)	Ethernet/RJ45 (Control) USB (Service/Update)	Ethernet/RJ45 (Control) USB (Service/Update)
<b>App Controllable</b>	YES - Bluetooth 4.0 Low Energy iOS or Android device.	YES - Bluetooth 4.0 Low Energy iOS or Android device.	YES - Bluetooth 4.0 Low Energy iOS or Android device.
<b>Adjustments via App</b>	Volume, Preset EQ Modes, Low Pass, Phase, Parametric EQ, Delay, Auto On/ Off, Automatic EQ/ Calibration	Volume, Preset EQ Modes, Low Pass, Phase, Parametric EQ, Delay, Auto On/ Off, Automatic EQ/ Calibration	Volume, Preset EQ Modes, Low Pass, Phase, Parametric EQ, Delay, Auto On/ Off, Automatic EQ/ Calibration
<b>Wireless</b>	Built-in wireless receiver. Compatible with ES-SUB-WIFI-TX- MEGA transmitter (sold separately).	Built-in wireless receiver. Compatible with ES-SUB-WIFI-TX- MEGA transmitter (sold separately).	Built-in wireless receiver. Compatible with ES-SUB-WIFI-TX- MEGA transmitter (sold separately).
<b>IP Control via RJ45</b>	Yes	Yes	Yes
<b>12v Trigger Input</b>	Yes	Yes	Yes
<b>Cabinet Color/Finish</b>	Gloss Black Satin Walnut Veneer	Gloss Black Satin Walnut Veneer	Gloss Black Satin Walnut Veneer
<b>Feet</b>	Non-slip rubber & Carpet spikes	Non-slip rubber & Carpet spikes	Non-slip rubber & Carpet spikes
<b>Dimensions (W x H x D)</b>	375.92 mm (14.8") x 345.44 mm (13.6") x 320.04 mm (12.6")	447.04 mm (17.6") x 452.12 mm (17.8") x 391.16 mm (15.4")	416.56 mm (16.4") x 472.44 mm (18.6") x 416.56 mm (16.4")
<b>Power Consumption</b>	IEC 2 Prong 100-120v / 220-240v, 50-60Hz	IEC 2 Prong 100-120v / 220-240v, 50-60Hz	IEC 2 Prong 100-120v / 220-240v, 50-60Hz
<b>Sold As</b>	Each	Each	Each
<b>Weight</b>	21.9 kg / 48.2 lbs	35.8 kg / 78.8 lbs	37.7 kg / 82.9 lbs

**NOTE:** MEGA subwoofer are built using some of the finest components and materials - as such, these are heavy. Two person lift is highly recommended.

## TROUBLESHOOTING

Episode® speakers are designed to function trouble-free. Most problems that occur are due to simple issues. If you have trouble, please check the list of simple fixes below. If the problem persists, contact Episode® Technical Support at 1.866.838.5052

### No Sound

- Verify the subwoofer is powered on.
- Verify that there is audio coming from the source selected. Select another source if necessary.
- Ensure that any A/V receivers are turned on and connected properly.
- Check cable connections at each subwoofer not producing sound for good contact.
- Ensure the subwoofer volume is turned up to a reasonable level. The control is located on the rear panel and in the Episode MEGA Subwoofer app.

## WARRANTY

10/2-Year Limited Warranty

Episode® Subwoofers have a 2-Year Warranty on the amplifier and a 10-Year Warranty on the woofer and box. This warranty includes parts and labor repairs on all components found to be defective in material or workmanship under normal conditions of use. This warranty shall not apply to products which have been abused, modified or disassembled. Products to be repaired under this warranty must be returned to SnapAV or a designated service center with prior notification and an assigned return authorization number (RA).

## CONTACTING TECHNICAL SUPPORT

As a thank you for purchasing Episode® Electronics products, direct technical support services are available via phone or e-mail. We encourage you to use this resource for any questions or concerns about our products. Visit our website for more support documentation.

(866) 838-5052

techsupport@snapav.com

snapav.com

Copyright ©2020, Wirepath Home Systems, LLC. All rights reserved. Control4 and Snap AV and their respective logos are registered trademarks or trademarks of Wirepath Home Systems, LLC, dba "Control4" and/or dba "SnapAV" in the United States and/or other countries. 4Store, 4Sight, Control4 My Home, Snap AV, Araknis, Autonomic, BakPak, Binary, Dragonfly, Episode, Luma, Mockupancy, Nearus, NEE0, OvrC, Pakedge, Sense, Strong, SunbriteTV, Triad, Visualant, WattBox, and Wirepath are also registered trademarks or trademarks of Wirepath Home Systems, LLC. Other names and brands may be claimed as the property of their respective owners. All specifications subject to change without notice.